

Digital Dental X-ray

Midmark Animal
Health Products



Disease you can't see...

60% of periodontal disease lies below the gum line, and many issues aren't detectable via probing or visual inspection.*

Don't let patients leave your clinic with undiagnosed disease. Only through the use of dental radiographs can you effectively diagnose dental disease that could result in tooth loss and many systemic diseases affecting the heart, liver and kidneys.



Teeth appear normal and healthy.



X-ray shows underlying pathology.

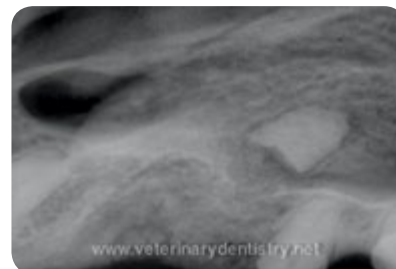

Post-extraction images allow you to spot remaining tooth fragments.

You can't afford not to invest in dental X-ray. VetPro® systems can pay for themselves in less than a year! Let us show you how.

* PetMD, Gum Disease in Dogs, www.petmd.com/dog/conditions/mouth/c_multi_periodontal_disease

VetPro® DC

Designed to enhance your clinic's efficiency

The VetPro® DC uses simple icons and a large, easy-to-read display for ease of use. You can select the mA, kV and time settings of your choice or choose the convenient pre-programmed technique settings. The positioning arm is constructed with high-tolerance, frictionless joints and a heavy duty dual braking system designed for precise and stable placement. The unique tube head handle is designed to let you effortlessly put the X-ray source where you want it, with just one hand.

- Intuitive, with easy-to-use, veterinary-specific software and control panel
- DC technology allows you to adjust kV (60, 65 and 70) and mA (4, 5, 6 and 7)
- A flexible system with settings you can customize to suit your practice
- 0.4 mm focal spot (smallest in the industry) is designed to produce visibly higher resolution images
- Optional sensor holder on arm available
- 56", 66", 76" or 82" arm lengths and versatile mobile system
- No-hassle installation - simply connect the USB cable to your PC, use the quick calibration flash drive to prepare your sensor, and the system is ready
- Superior construction – made in the U.S.A.
- Before, during and after sale support

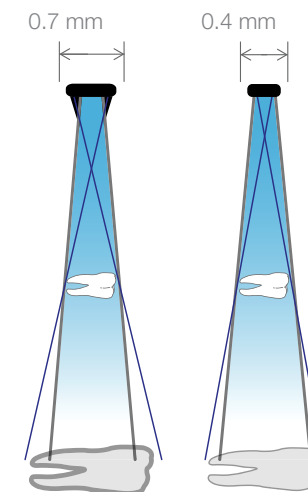

The VetPro® DC 0.4 mm focal spot is designed to produce visibly higher resolution images whether you're using film or digital sensors. Details are sharper and more defined. Small but important differences are easier to spot. Pathologies are easier to identify.



Midmark—the digital dental X-ray experts

VetPro[®] DR Digital Dental Radiography Sensor

The VetPro[®] DR sensor is designed to allow you to get the soft-tissue visualization plus crown and root definition that you need to ensure you are providing your patients with superior dental care.

- Cable is Kevlar[®] reinforced, designed for improved durability
- Waterproof, hermetic seal is designed to reduce problems encountered during routine cleaning
- CMOS technology designed to deliver enhanced image quality
- High-speed USB connection designed to capture images 37% faster
- Rounded corners means easier positioning in tight spaces for better capture of roots
- Ask us about our Sensor Safe[®] Extended Care and Factory Warranty Extension programs



VetPro[®] CR Digital Dental Radiography Reader

Do you prefer to use phosphor plates?

The VetPro[®] CR is designed to be an easy to use and affordable dental imaging solution from the name you trust. Who says high-quality dental imaging needs to be complicated or expensive?

The VetPro[®] CR Dental Radiography Reader was designed to provide the following features and resulting benefits for your clinic:

- Rapid, high-quality readings
- Low maintenance with no brushes. Helps reduce image artifacts from hair, etc.
- Size 4c plate available – large enough to capture larger teeth but small enough for easier positioning
- Affordable and compact veterinary dental solution
- Progeny[®] Imaging Software included at no additional cost after purchase
- Easy-to-use LCD touchscreen interface
- Utilize existing X-ray equipment and imaging techniques
- Standard and high resolution options
- Easy-to-position, reusable imaging plates
- Built-in erase function
- Streamlined unit for ease of cleaning
- Software optimizes acquisition, processing and management
- USB connection
- Eliminate darkroom and chemicals
- Auto calibration ensures stability and consistency
- Aids in marketing your practice's use of digital technology
- Size 2 and 4c imaging plates are included with the unit – sizes 0, 1, 2, 3 and 4c available for purchase



Midmark Animal Health is known in the industry for our market-leading digital X-ray machine, trusted digital imaging systems, intuitive software and an unmatched, nationwide support and service network.



Phosphor plates are designed to have the following benefits:

- Thin, flexible imaging plates with no cables
- Imaging plates offer 100 percent active area
- Familiar workflow and accessories comparable to film, allowing for seamless integration into the practice
- No need for cleaning after each use
- Use multiple plates during one procedure
- Plates are inexpensive to replace

Our imaging software has been designed with a look and formatting that's familiar and easy to learn so you'll be acquiring, enhancing and storing images in no time.



VetPro[®] Complete Digital Dental Radiography Systems

Whether your clinic is equipped with film, fully digital or a combination of both, we feel you should have the freedom to choose what you are most comfortable using without sacrificing the quality, service and support that you've come to expect from the Midmark brand. That's why we provide you with multiple imaging options and the training and support you need to get the best use of your equipment.

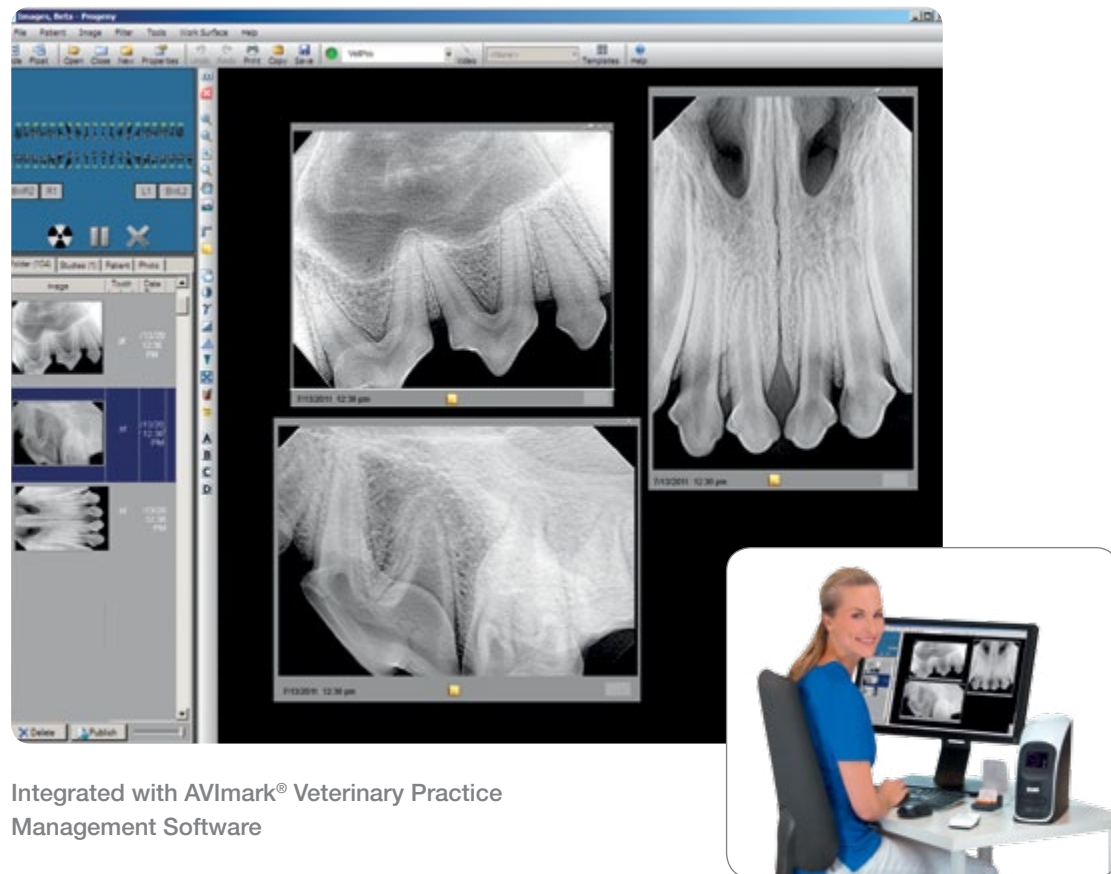

Integrated with AVImark[®] Veterinary Practice Management Software



VetPro[®] Complete CR



VetPro[®] Complete DR

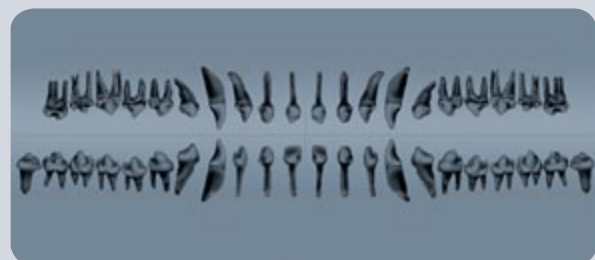

Canine Tooth Panel



Feline Tooth Panel

VetPro[®] Complete Mobile Imaging Station

A digital imaging solution that includes a VetPro[®] Complete Mobile unit with #2 sensor, laptop pre-loaded with imaging software and laptop tray.



VetPro® DC Specifications

Line Voltage: 120-230 VAC
+/- 10% 50-60 Hz

Line Load: Maximum current amps

Tube Potential: 60, 65 or 70 kV

Tube Current: 4, 5, 6 or 7 mA

Exposure Time: 20 ms to 2 seconds

Cone Length: 20 cm (8 inches)

Minimum Inherent Filtration: 2 mm Al equivalent at 70 kV

Focal Spot: 0.4 mm (IEC 336)

Duty Factor: 1:15

Remote exposure hand switch included

Shipping Weight: 95 lb (wall mount) 330 lb (mobile)

Applicable Documents Federal Regulations: 21 CFR, UL, CE

Warranty: 2 years, limited

VetPro® CR Specifications

Selectable Pixel Size: High 35µm · Standard 64µm

Sampling Pixel Pitch (35µm): 14.3 lp/mm

Readout Time: 4.1 ~ 7.2 sec

Resolution: Data Capture 16-bits per pixel, 65,000 graytones

Eraser: Embedded

Dimensions 10.4" (H) x 4.7" (W) x 12.5" (D)/265 (H) x 120 (W) x 318 (D) mm

Weight: 10.4 lb (4.7 kg)

System Configuration: Tabletop

Interface: USB 2.0 high speed (480 Mbps)

Power Requirements: 100 ~ 240V/50 ~ 60Hz, 30W · UPS required

Warranty: 1 year

VetPro® DR Sensors Specifications

Dimensions:
Size 1 (film size equivalent) 37 mm x 24 mm x 6 mm
Size 2 (film size equivalent) 43 mm x 30 mm x 6 mm

Active Area:
Size 1 (film size equivalent) 30 mm x 20 mm
Size 2 (film size equivalent) 36 mm x 26 mm

Number of Pixels:
Size 1 (film size equivalent) 1580 lines x 1050 pixels
Size 2 (film size equivalent) 1896 lines x 1368 pixels

Pixel Size: 19 µm x 19 µm

Theoretical Resolution: 26 lp/mm

Levels of Grey: 4096

Connection Type: High-speed USB 2.0

Sensor Cable Length: 3 meters

Warranty: 2 years

Progeny® Vet Imaging Software

Computer Workstation Requirements:

Operating System: Windows® 8 Pro or Enterprise Edition (32 & 64 bit), Windows® 7 Ultimate or Professional (32 & 64 bit)

Processor: Intel® (or x86 compatible) Single Core™ 2 GHz or better (or Dual Core™ at 1.7 GHz recommended),

Memory: 2 GB RAM (minimum), 3 GB RAM (recommended),

Storage: 80 GB Hard Drive (minimum)

Video: 32 bit, 1024 x 768 resolution capable (minimum)

Display: 1024 x 768, 32 true bit color (recommended)

Ports: Two High-Speed USB 2.0

Options: choice of 56", 66", 76" or 82" (total reach); double stud mounting plate

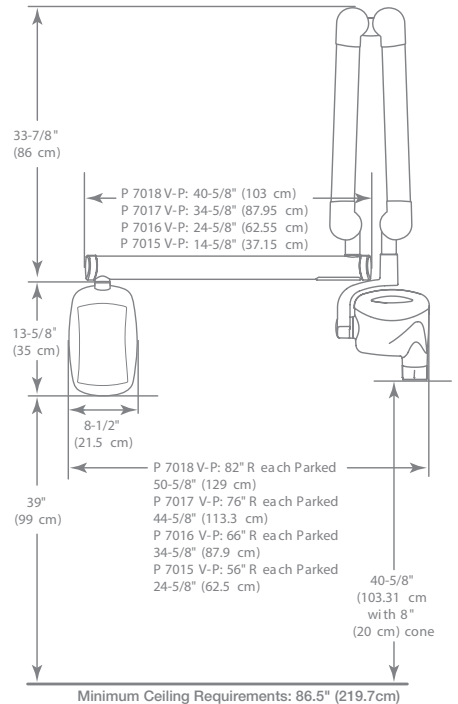
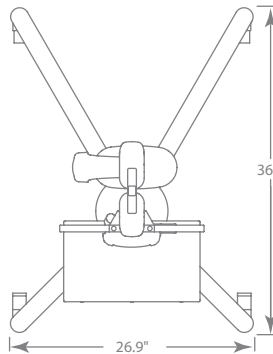
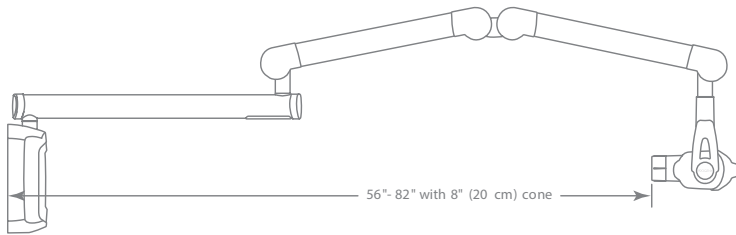

Authorized Representative:

CEpartner4U
Esdoornlaan 13
3951DB Maarn
The Netherlands
www.cepartner4u.eu

Better Patient Care. Better Business.™

midmarkanimalhealth.com

X-ray, Radiography Sensors, Mobile Station - Manufactured by Midmark Corporation, Lincolnshire, IL.
Radiography Reader, Plates - Manufactured by 3D Imaging and Simulations Corp, Yuseong-gu, Daejeon, Korea, for distribution by Midmark Corporation, Versailles, OH.

© 2011 Midmark Corporation • Products subject to improvement changes without notice • Litho in U.S.A. • 007-0899-00 Rev. F1 (11/15)
Midmark is an ISO 13485 Certified Company.



Because we care.