

# Hydrogen Peroxide Plasma Sterilizer



100L/130L/190L



# An Intelligent Solution For The CSSD

A trusted solution for sterilizing MIS instruments.



## Why low temperature sterilization

Many components of today's advanced surgical tools cannot tolerate the high heat of steam sterilizers. Demand for low-temperature alternatives has driven manufacturers to create safer, faster low-temperature sterilizers. Markets and Markets predicts that the technology will become an essential element of ORs and central sterile processing departments in the next few years.

## Why Plasma

- Broad material and device compatibility
- Fast cycle times
- No need civil work
- Non-toxic by product
- Low temperature, low moisture
- Low running costs
- Low maintenance costs



<https://hnsqylqi.en.alibaba.com/>

# Brand Component Build Reliable Quality



Vacuum pump



Air pressor

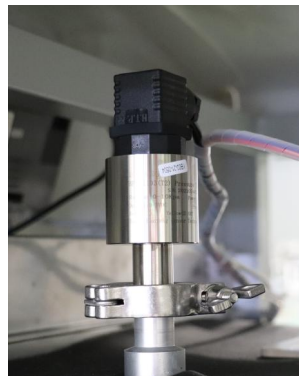

Sensor

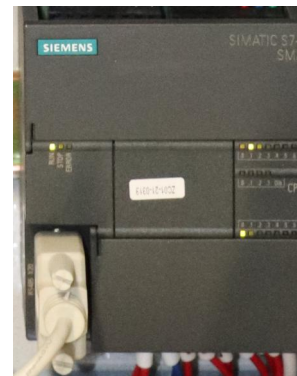

Siemens PLC



Printer



Cassette sterilant

# Outline sketch

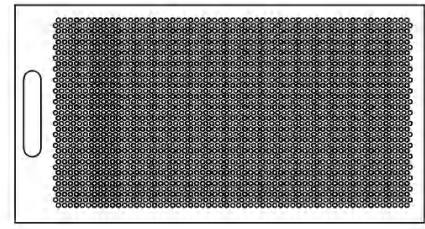
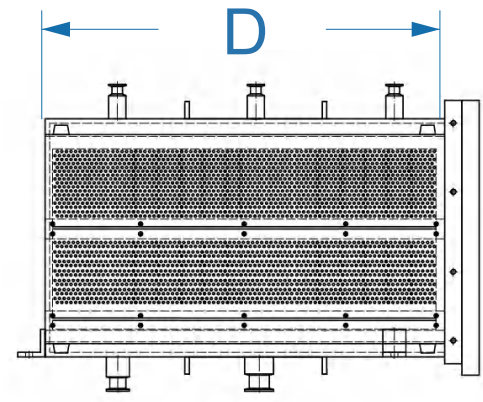
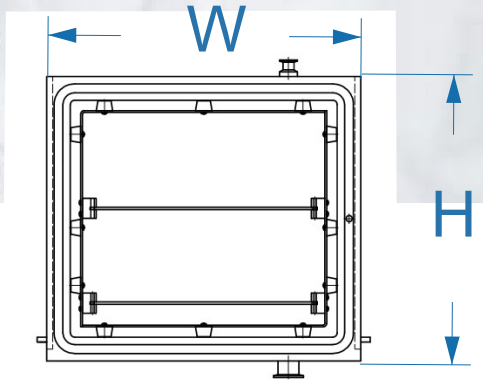
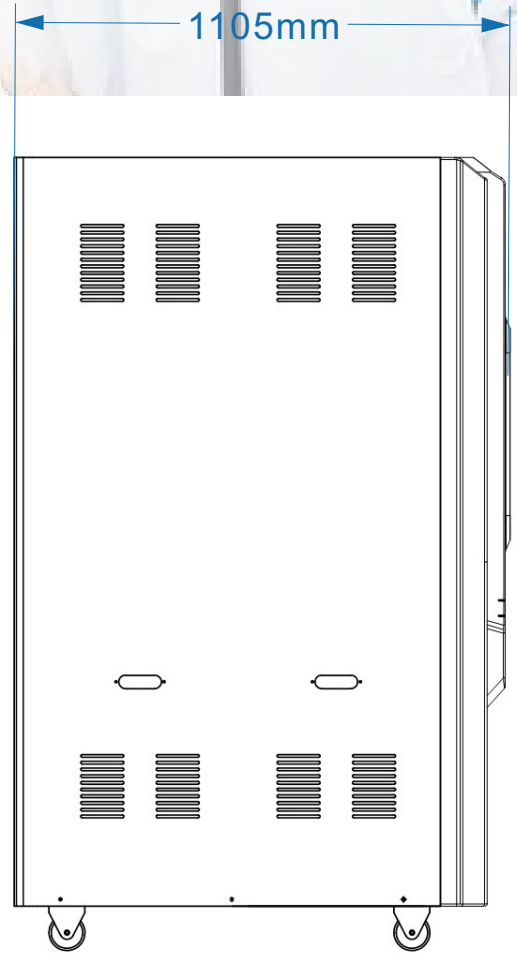
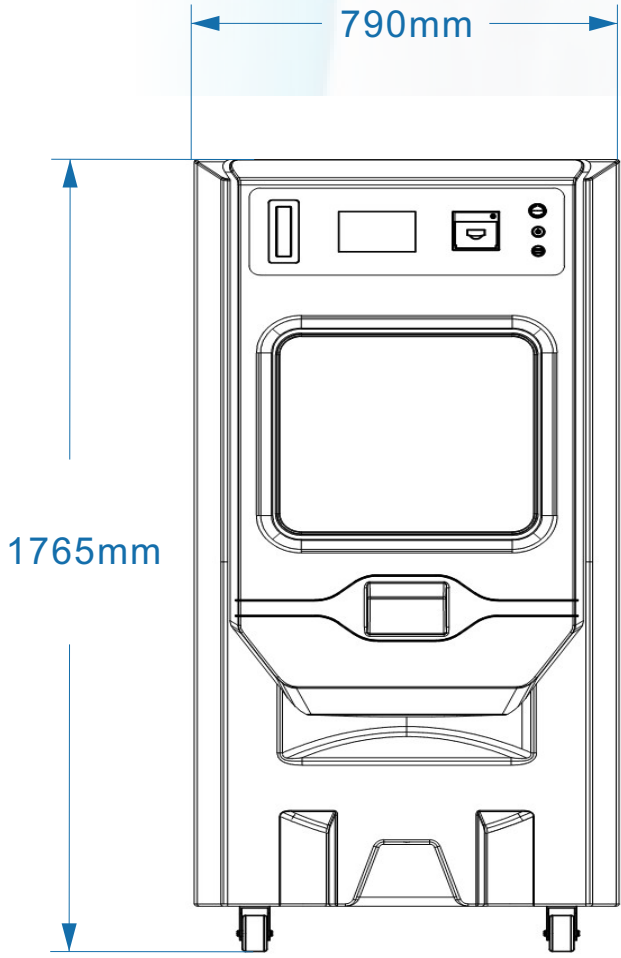

# Scope of application

A trusted solution for sterilizing MIS instruments.

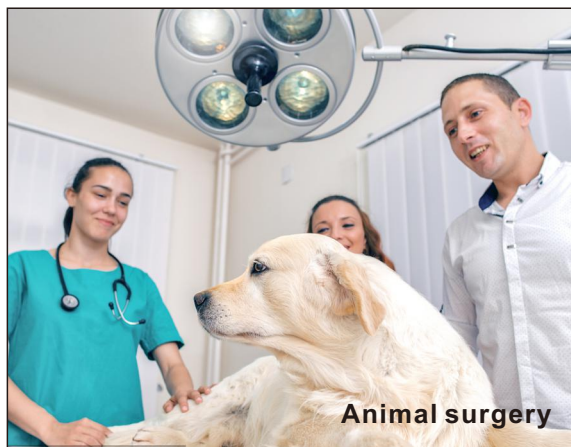
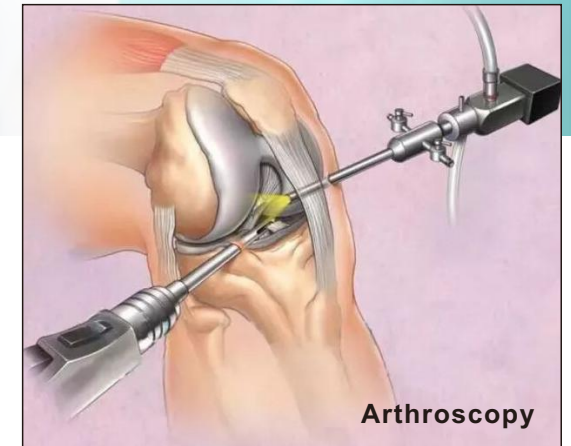
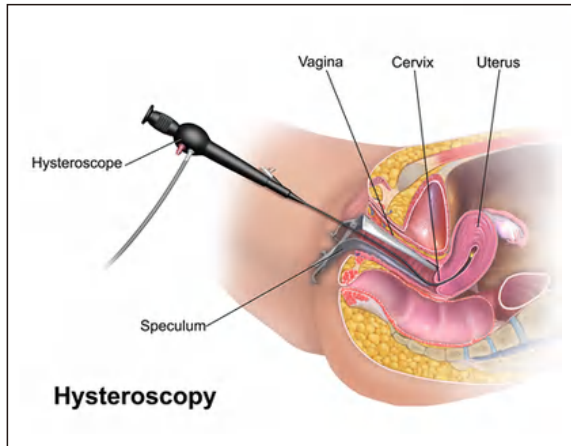

## Technical information

<b>Model</b>	SQ-DZ100	SQ-DZ130	SQ-DZ220
<b>Machine size (W x H x D)</b>	1105 x 790 x 1765 mm	1105 x 790 x 1765 mm	1105 x 790 x 1765 mm
<b>Chamber size (W x H x D)</b>	700 x 430x 360 mm	750 x 450x 400 mm	820x 510x 460 mm
<b>Volume</b>	108L	135L	192L
<b>Power</b>	3.5KVA	4.2KVA	4.8KVA
<b>Weight</b>	265KG	272KG	305KG
<b>Sterilization cell</b>	Aluminum alloy	Aluminum alloy	Aluminum alloy
<b>Shelves (trays)</b>	Two	Two	Two
<b>Sterilization pressure</b>	50Pa	50Pa	50Pa
<b>Sterilization temperature</b>	45 - 55	45 - 55	45 - 55
<b>Air intake</b>	Through medical-grade HEPA filter	Through medical-grade HEPA filter	Through medical-grade HEPA filter
<b>Dose method</b>	H2O2 solution Cassette	H2O2 solution Cassette	H2O2 solution Cassette
<b>Mini printer</b>	Yes	Yes	Yes
<b>Excess humidity alarm</b>	Yes	Yes	Yes
<b>Display screen</b>	7'color LCD	7'color LCD	7'color LCD
<b>Date export</b>	Yes	Yes	Yes

# Plasma Sterilization Supplies

---

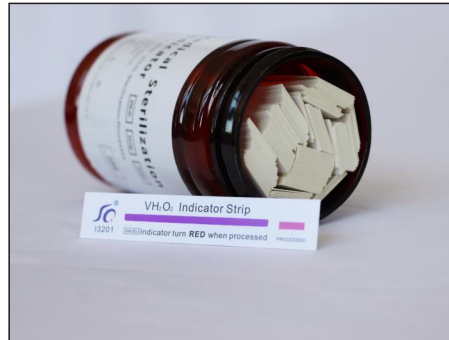

Plasma strip



Plasma biological indicator



Plasma tape



Plasma pouch

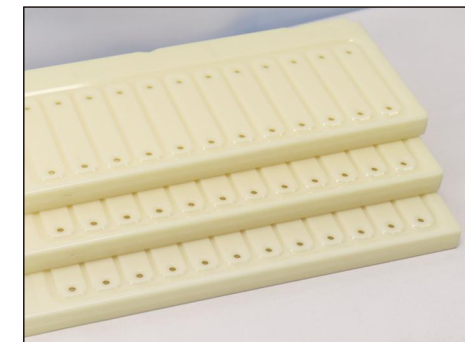

Sterilant Cassette



Distributor for Greece Cyprus Albania

**PETLINE SA - Finos Film Str SPATA GREECE**

[info@petline.gr](mailto:info@petline.gr)

Tel:+302106069800

